

LES BAER 1911 ULTIMATE RECON

AIRSOFT TOY GUN DISTRIBUTED BY SOCOM GEAR

USER MANUAL

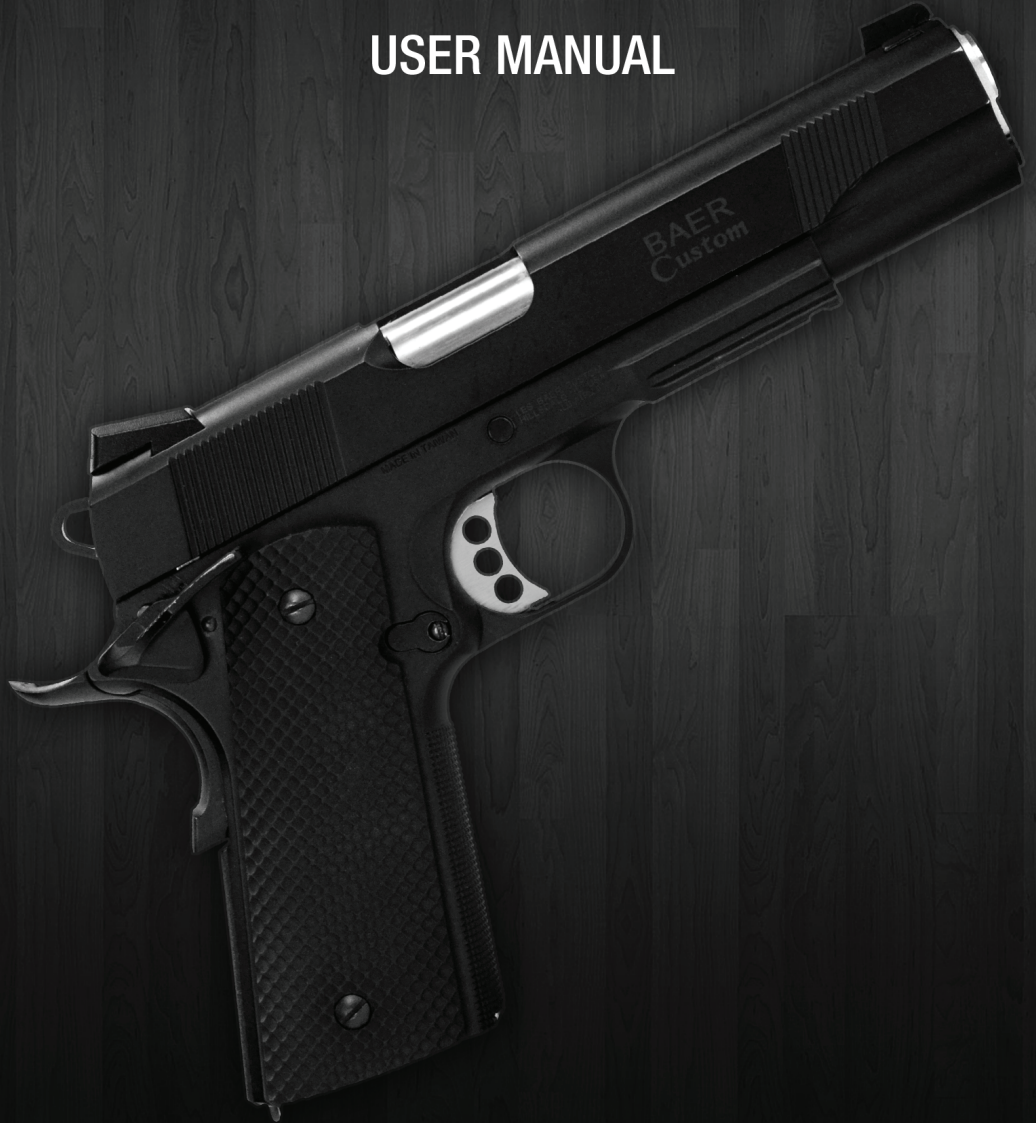

"For ages 18 and older"
"Read operators manual before use"
"Please leave your questions or comments
at www.socomgear.com"
"email: info@socomgear.com"

WARNING:
Don't change, obscure, alter, remove, or obliterate any coloration or markings on this gun. The coloration and/or marking on this product, including the blaze orange barrel lip are designed to comply with applicable state and federal law and regulations.

WARNING:
This product may be mistaken for a firearm by law enforcement officers or others. Any person who changes, alters, removes, or obliterate any coloration or markings that are required by state or federal law or regulation, in any way that makes this product look more like a firearm is guilty of a misdemeanor.

WARNING:
The open display, brandishing and/or exposing of this product in any "public place" may cause confusion and may be a crime. The term "public place" means any area opened to public, including but not limited to, streets, sidewalks, bridges, alleys, plazas, parks, driveways, front yards, parking lots, automobiles, whether moving or not, and buildings opened to the general public including those that serve food or during, or provide entertainment, and the doorways and entrances to buildings or dwellings.

WARNING:
Every person who, except in self-defense, draws or exhibits this product in a threatening manner against another in such a way as to cause a reasonable person apprehension or fear of bodily harm is guilty of a misdemeanor punishable by imprisonment in the county jail for a term of not less than 30 days.



Warning:

You have to read manual and agree and understand all terms, conditions, warnings before you operate Airsoft guns

Everyone wear goggles when you operate Airsoft guns. Don't peek at the muzzle.

Put the toy gun beyond the reach of kids. Don't touch the trigger until the moment of shooting.

Don't aim at people even if it is unloaded. Avoid a rough operation.

When the gun is not in use, remove the magazine and unload the BB. Remember, there might be one BB in the chamber. Use a rod to push it out.

WARNING: Don't change, obscure, alter, remove, or obliterate any coloration or markings on this gun. The coloration and/or marking on this product, including the blaze orange barrel tip are designed to comply with applicable state and federal law and regulations.

WARNING: This product may be mistaken for a firearm by law enforcement officers or others. Any person who changes, alters, removes, or obliterate any coloration or markings that are required by state or federal law or regulation, in any way that makes this product look more like a firearm is guilty of a misdemeanor.

WARNING: The open display, brandishing and/or exposing of this product in any "public place" may cause confusion and may be a crime. The term "public place" means any area opened to public, including but not limited to, streets, sidewalks, bridges, alleys, plazas, parks, driveways, front yards, parking lots, automobiles, whether moving or not, and buildings opened to the general public including those that serve food or during, or provide entertainment, and the doorways and entrances to buildings or dwellings.

WARNING: Every person who, except in self-defense, draws or exhibits this product in a threatening manner against another in such a way as to cause a reasonable person apprehension or fear of bodily harm is guilty of a misdemeanor punishable by imprisonment in the county jail for a term of not less than 30 days.

WARNING: Assumption of Risks There is a serious risk of personal injury, death, or property damage arising out of the use or misuse of this product. By using this product, you agree to freely accept and full assume all such risks.

WARNING: Exclusion of Liability In consideration of SOCOM GEAR / MAX Tactical corp granting you the limited warranty set out hereinbelow, neither SOCOM GEAR/ MAX Tactical corp, nor its officers, directors, employees, agents, successors, distributors and dealers (all of whom are hereinafter collectively referred to as the "releasees"), shall be liable for any loss or damage whatsoever, whether general, direct, indirect, special, incidental, consequential, punitive, aggravated or exemplary and whether resulting from ordinary or gross negligence, breach of contract, or breach of any statutory, regulatory or common law duty, and whether such loss or damage is caused to or by this product or by any other product due to any incompatibilities between them or by defects or malfunctions in connection with the use of this product (even if the releasees are advised of the possibility of such loss).

WARNING: Indemnification In consideration of SOCOM GEAR / MAX Tactical corp granting you the limited warranty set out hereinbelow, you agree to indemnify the releasees of any liability, damages, legal costs, fees, disbursements, expenses, or any other costs whatsoever, arising out of any claims, suits, or actions brought by a third party against the releasees or any of them in which the third party claims to have suffered any loss or damage that was caused by, contributed to, or related in any way to the use or misuse of this product.

WARNING: Limited Warranty SOCOM GEAR / MAX Tactical corp warrants that this product is constructed using plastic, steel and Aluminum. This product is provided without another warranty of any kind, either statutory, expressed or implied, including but not limited to, the implied warranties or implied, including but not limited to, the implied warranties of merchantability, fitness for a particular purpose, title, non-infringement, or arising from a course of dealing, the releasees make no warranties or representations of any kind as to the fitness of this product for any particular purpose.

WARNING: Choice of Law The laws of the province of Taiwan and the laws of Republic of China applicable therein shall govern as to the interpretation, validity and effect of this agreement notwithstanding any conflict of laws provisions of your domicile, residence or physical location. You consent and submit to the exclusive jurisdiction of the courts of the Province of Taiwan in any action or processing instituted under or related to this agreement, or to the alleged breach of contract, negligence, gross negligence, or breach of statutory or common law duty of the Releasees.

OPERATION



1. REMOVE THE MAGAZINE:
Press magazine catch and
remove magazine.

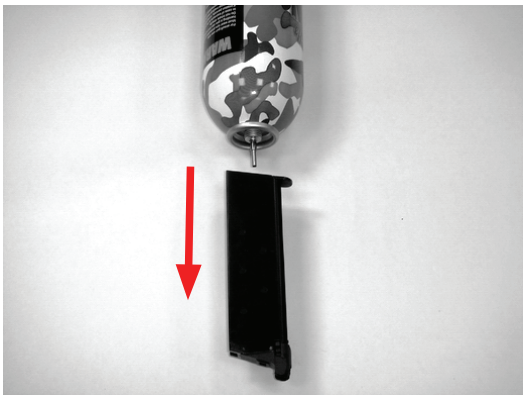

2. FILLING GAS
Insert the gas bottle into
the magazine vertically and
fill with gas.

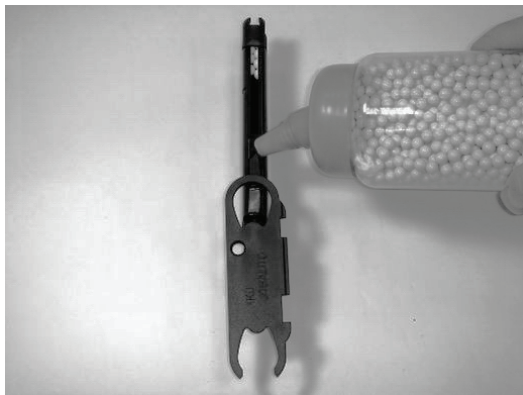

3. LOADING BBs
Use a wrench to hold
follower and fill with BBs.



4. INSERT MAGAZINE

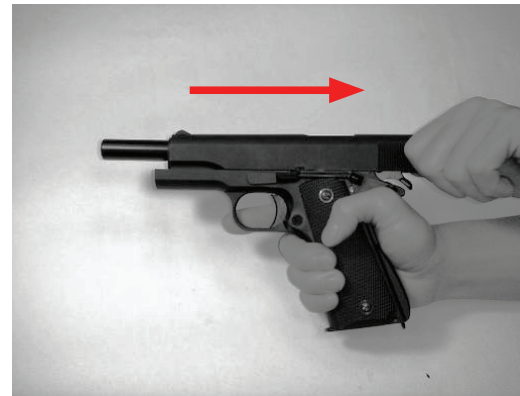

5. LOAD
Pull the slide back
completely.



6. FIRE
Pull the trigger to fire.

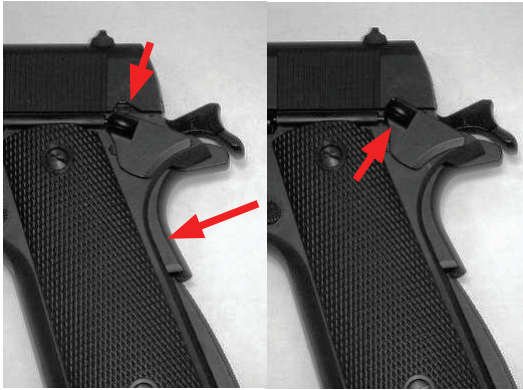

7. SAFETY OPERATION
Left:
Safety OFF, ready to fire.

Right:
Safety ON,

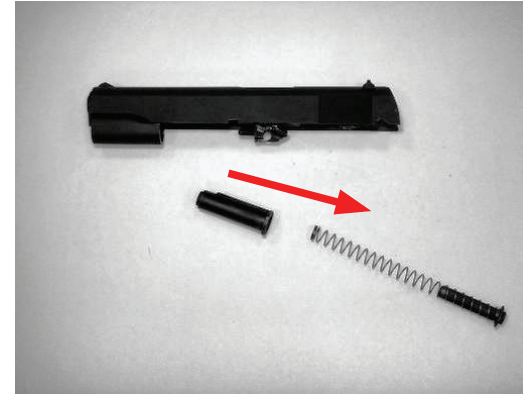

3. REMOVE RECOIL SPRING
AND SPRING CAP

DISASSEMBLY



1. REMOVE SLIDE STOP
Press magazine catch and
remove magazine.

Move the slide rear until the
takedown notch is just above
the slide stop tab and
remove slide stop.

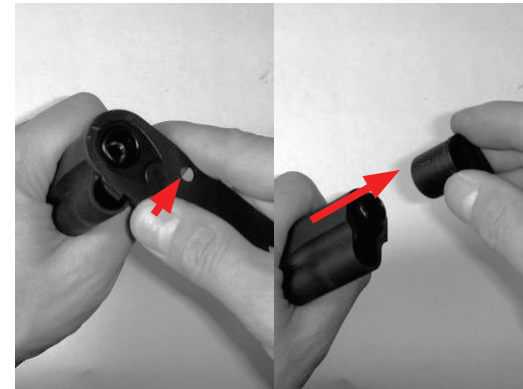

4. REMOVE BARREL BUSH
Use a wrench to rotate the
barrel bush and remove it.



2. REMOVE THE SLIDE

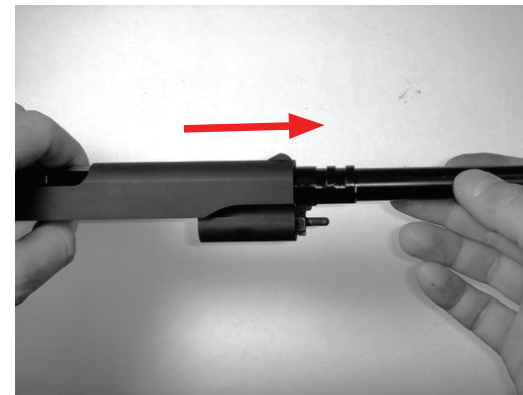

5. REMOVE BARREL

ASSEMBLY

REVERSE DISASSEMBLY ORDER

ADJUST TRAJECTORY



TWIST THE ADJUST DIAL TO ADJUST TRAJECTORY

SOCOM GEAR LES BAER 1911 EXPLODED VIEW

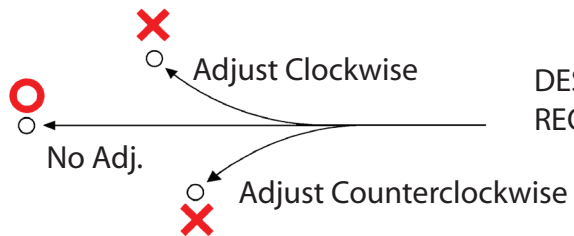
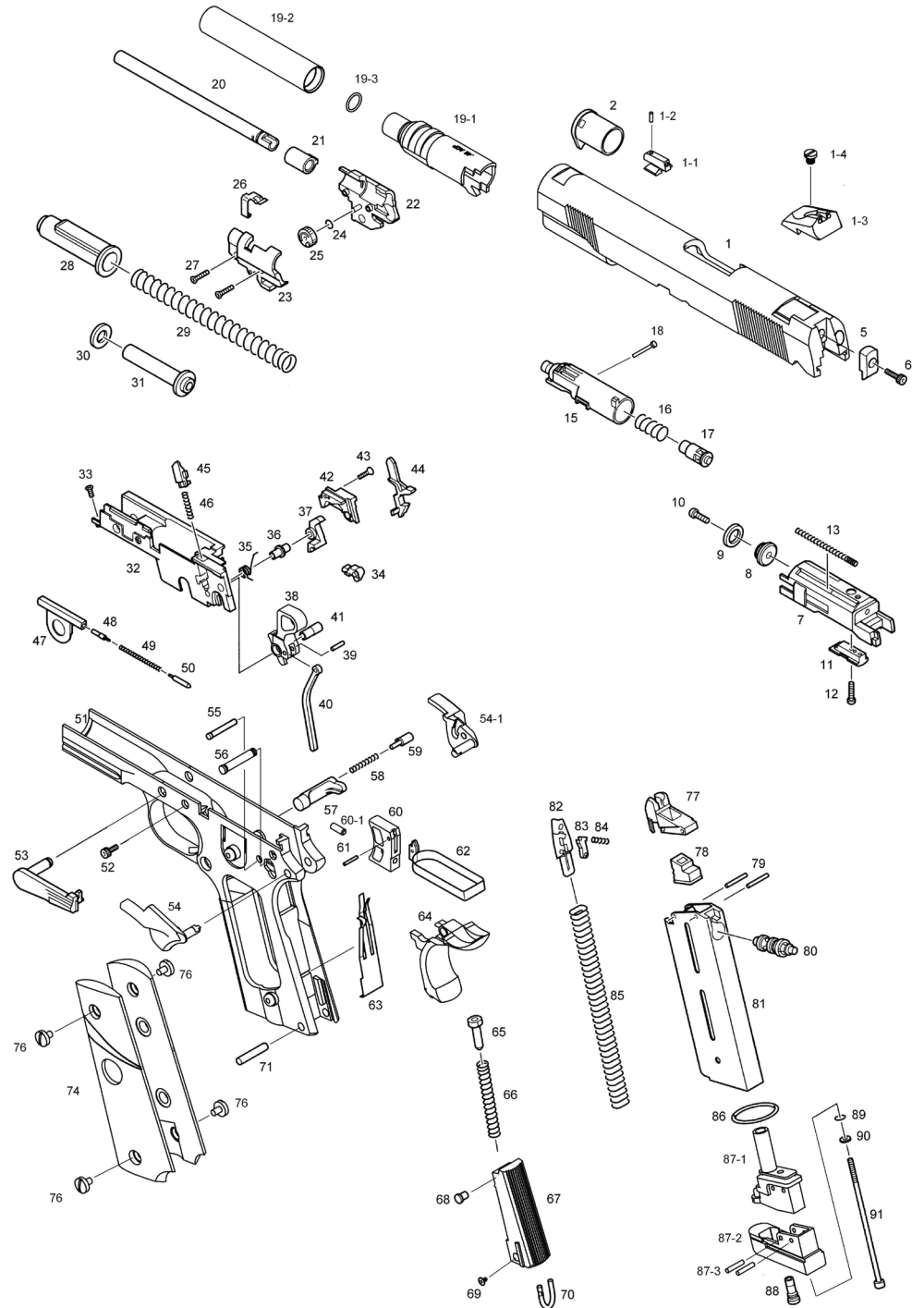

DESIRED TRAJECTORY / REQUIRED ADJUSTMENT

No.	Name of Part
1	Slide
1-1	Front Sight
1-2	Front Sight Screw
1-3	Rear Sight
1-4	Rear Sight Screw
5	Firing Pin Stop
6	Firing Pin Stop Screw
7	Cylinder
8	Ring Head
9	Ring
10	Ring Head Screw
11	Piston Part
12	Piston Part Screw
13	Cylinder Return Spring
14	Cylinder Screw
15	Cylinder
16	Cylinder Valve Spring
17	Cylinder Valve
18	Cylinder Valve Stopper
19-1	Outter Chamber
19-2	Outter Barrel
19-3	Outter Barrel O-Ring
20	Inner Barrel
21	Rubber Chamber
22	Chamber Cover (Right)
23	Chamber Cover (Left)
24	O-Ring
25	Adjust Dial
26	Adjust Lever
27	Chamber Cover Screw
28	Recoil Plug
29	Recoil Spring
30	Recoil Spring Pad
31	Recoil Spring Guide
32	Front Chasis
33	Front Chasis Screw
34	Knocker
35	Knocker Spring
36	Sear Sleeve
37	Sear
38	Hammer
39	Hammer Strut Pin
40	Hammer Strut
41	Hammer Sleeve
42	Chassis Cover
43	Chassis Cover Screw
44	Disconnecter
45	Knocker Lock

No.	Name of Part
46	Knocker Lock Spring
47	Plunger Guide
48	Slide Stop Plunger
49	Plunger Spring
50	Safety Plunger
51	Frame
52	Frame Screw
53	Slide Stop
54	Safety
54-1	Safety(Right)
55	Sear Pin
56	Hammer Pin
57	Magazine Catch
58	Magazine Catch Spring
59	Magazine Catch Lock
60	Trigger
60-1	Trigger Screw
61	Trigger Pin
62	Trigger Bar
63	Sear Spring
64	Grip Safety
65	Hammer Spring Plunger
66	Hammer Spring
67	Hammer Spring Housing
68	Plunger Stopper
69	Lanyard Loop Screw
70	Lanyard Loop
71	Housing Pin
74	Grip
76	Grip Screw
77	BB Lip
78	Magazine Gasket
79	BB Lip Pin
80	Valve
81	Magazine Case
82	Follower
83	Follower Lever
84	Follower Lever Spring
85	Follower Spring
86	O-Ring
87-1	Magazine Bottom-1
87-2	Magazine Bottom-2
87-3	Magazine Bottom Pin
88	Filling Valve
89	O-Ring
90	Washer
91	Magazine Base Screw

NEW FROM SOCOMGEAR

New fully licensed Airsoft pistols distributed by SOCOM GEAR

Doublestar 1911 Combat Pistol



Kel Tec PMR 30



Gemtech Oasis



New fully licensed Airsoft products from Madbull Airsoft



18
 "For ages 18 and older"
 "Read operators manual before use"
 "Please leave your questions or comments at www.socomgear.com"
 "email: info@socomgear.com"

WARNING:
 Don't change, obscure, alter, remove, or obliterate any coloration or markings on this gun. The coloration and/or marking on this product, including the blaze orange barrel lip are designed to comply with applicable state and federal law and regulations.
WARNING:
 This product may be mistaken for a firearm by law enforcement officers or others. Any person who changes, alters, removes, or obliterate any coloration or markings that are required by state or federal law or regulation, in any way that makes this product look more like a firearm is guilty of a misdemeanor.

WARNING:
 The open display, brandishing and/or exposing of this product in any "public place" may cause confusion and may be a crime. The term "public place" means any area opened to public, including but not limited to, streets, sidewalks, bridges, alleys, plazas, parks, driveways, front yards, parking lots, automobiles, whether moving or not, and buildings opened to the general public including those that serve food or dining, or provide entertainment, and the doorways and entrances to buildings or dwellings.
WARNING:
 Every person who, except in self-defense, draws or exhibits this product in a threatening manner against another in such a way as to cause a reasonable person apprehension or fear of bodily harm is guilty of a misdemeanor punishable by imprisonment in the county jail for a term of not less than 30 days.